

# X3<sup>ST</sup> / X2<sup>ST</sup> / X1<sup>ST</sup>

LED surgical lights  
with single colour temperature



# *Surgiris*

*Design that cares*



Operating theatre

# CHANGE YOUR VISION / ST SERIES

The X3<sup>ST</sup>, X2<sup>ST</sup> and X1<sup>ST</sup> lights are innovative LED surgical lights. Designed by SURGIRIS, they provide integrated intelligent control of the LEDs as well as the exclusive patented **FOCUSMATIC™** technology. **Compact, efficient and functional**, they are well suited to general surgeries.

X3<sup>ST</sup>, X2<sup>ST</sup> and X1<sup>ST</sup> are LED surgical light with fixed colour temperature (ST: Single Temperature). SURGIRIS also manufactures LED surgical light with adjustable colour temperature: X3<sup>MT</sup> and X2<sup>MT</sup> (MT: Multi-Temperature)



# TECHNOLOGICAL INNOVATION

Change your vision – discover innovative lighting systems.

The recent technological breakthrough in the field of light-emitting diodes (L.E.D) have enabled the development of surgical lights with higher performance and reliability.

## The advantages of LED lights:

- Production of homogeneous, cool light with no UV or IR radiation
- Controlled color temperature
- Longer lifetime
- Operating safety
- Energy savings thanks to improved luminous efficiency

It is also easier to mount LEDs on a printed circuit board. LEDs assemblies can be programmed, like a computer, for precise control of the lighting parameters and other functions.

## Patented FOCUSMATIC™ system

The SURGIRIS LED surgical lights are the only surgical lights based on the innovative patented FOCUSMATIC™ technology.



Equipped with sophisticated electronic management of the LEDs, and combined with an individual optical device for each LED, FOCUSMATIC™ technology revolutionizes the “focus” function of the surgical lights.

## Intelligent LED control

Each LED is managed, protected and controlled electronically.  
Full of technologies:



CCL: maintains performance throughout the LEDs life time



EFA: electronic focalization system, adjustment of the diameter of the illuminated spot without mechanical movement



APM: automatic preventive maintenance for the LEDs



WCT: wireless communication



# DESIGN

◆ **X3<sup>ST</sup>** is a LED surgical light consisting of an aluminum open body, with three petals.

● **LED petal:** the LED sets allow constant central lighting level – regardless of the illuminated field diameter – and colour temperature, while providing a CRI of 91.

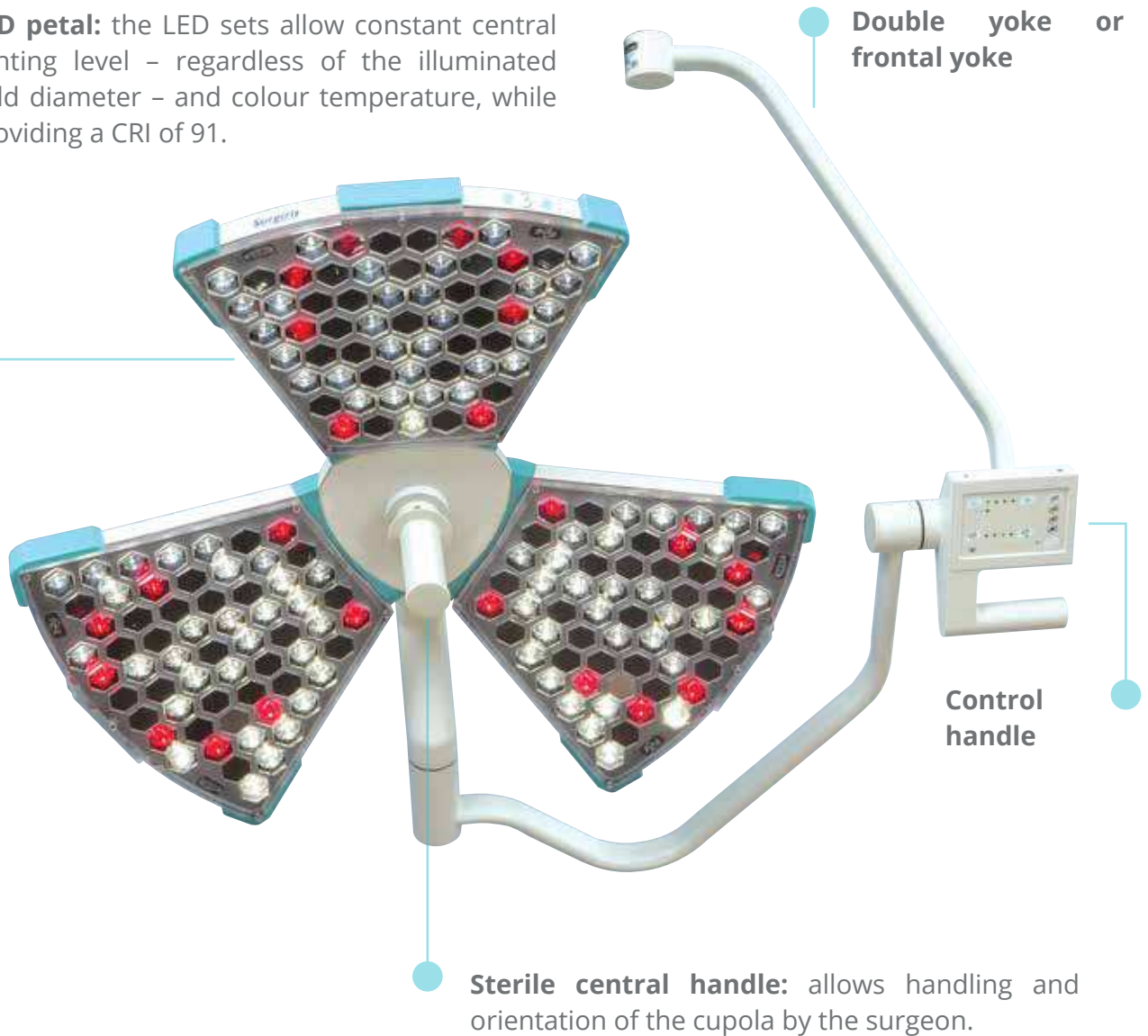

Each LED module (petal) is equipped with an independent optic device and a separate electronic system. The control handle allows the adjustment of the lighting parameters:



**Illumination level**



**Diameter of the illuminated field**



**Activation of the ENDO mode**

**X2<sup>ST</sup>** is a LED surgical light consisting of an aluminum open body, with two petals.

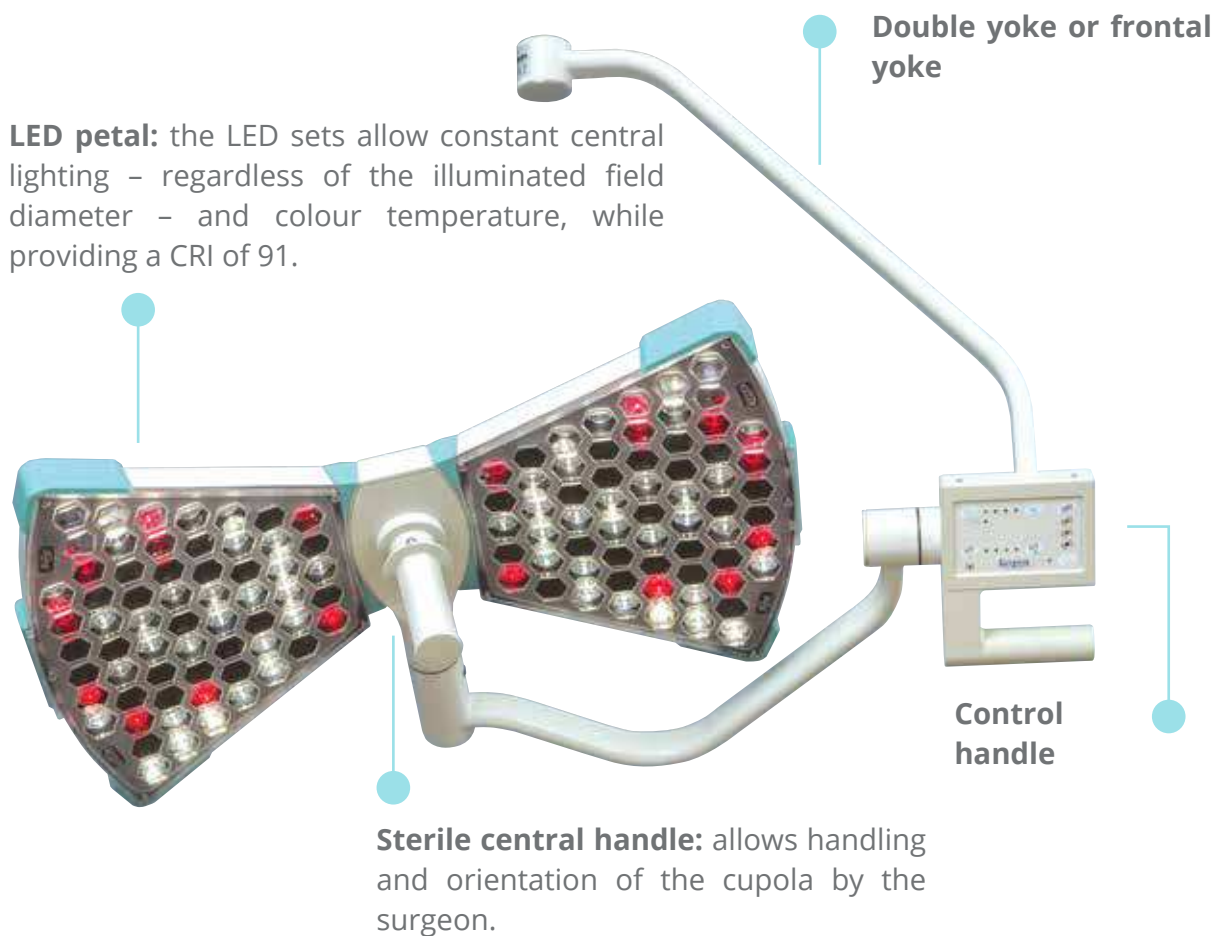

**X1<sup>ST</sup>** is a LED surgical light.



The X3<sup>ST</sup>, X2<sup>ST</sup> and X1<sup>ST</sup> lights consist of an open body that allows free circulation of ventilation air. They are suitable for operating theatres equipped with ceiling-mounted airflow or laminar flow modules (refer to DIN 1946 part 4)

# VISION COMFORT

High performance for demanding surgeries

## Large illuminated fields

FOCUSMATIC™ technology allows the adjustment of the illuminated field diameter up to a very large spot size with no loss of central lighting intensity.

X3<sup>ST</sup> model:

- Up to **160 000 Lux** with an illuminated spot adjustable up to a diameter of **33 cm**

X2<sup>ST</sup> model:

- Up to **160 000 Lux** with an illuminated spot adjustable up to a diameter of **31 cm**

X1<sup>ST</sup> model:

- Up to **100 000 Lux** with an illuminated spot adjustable up to a diameter of **33 cm**

Thanks to Surgiris' unique technology, the central illumination ( $E_c$ ) remains constant regardless of the illuminated field diameter.

### Illuminated spots obtained with:

#### LED lighting with classic focalization system

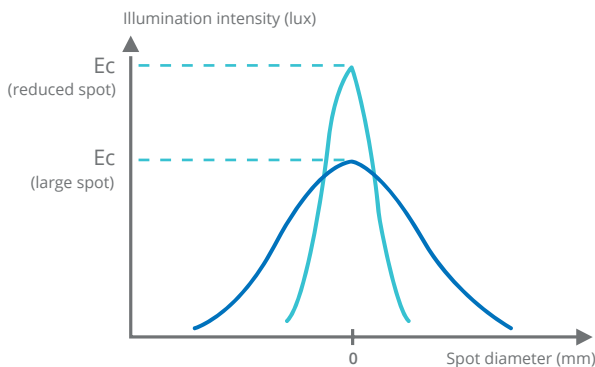

#### SURGIRIS LED lighting with patented FOCUSMATIC™ system

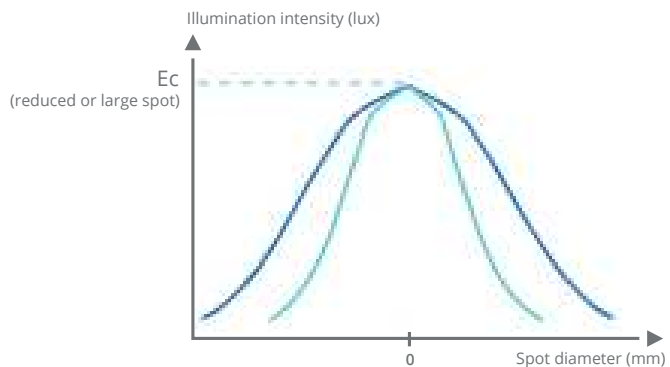

- Maximum focal length, large spot
- Minimum focal length, reduced spot

## Maintaining lighting performance



The LEDs electronic control is configured so as to maintain constant luminous intensity and color temperature throughout each surgical procedure. These are maintained continuously, even after several hours' operation.

#### LED lighting without CCL\*

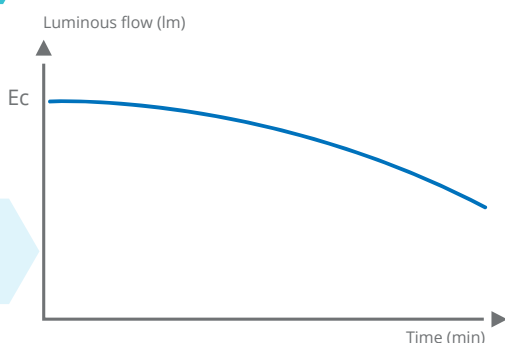

#### SURGIRIS LED lighting with CCL

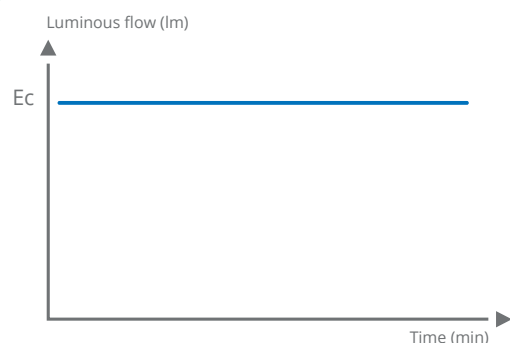

\* or other system of LED luminous flow management

### Depth of field

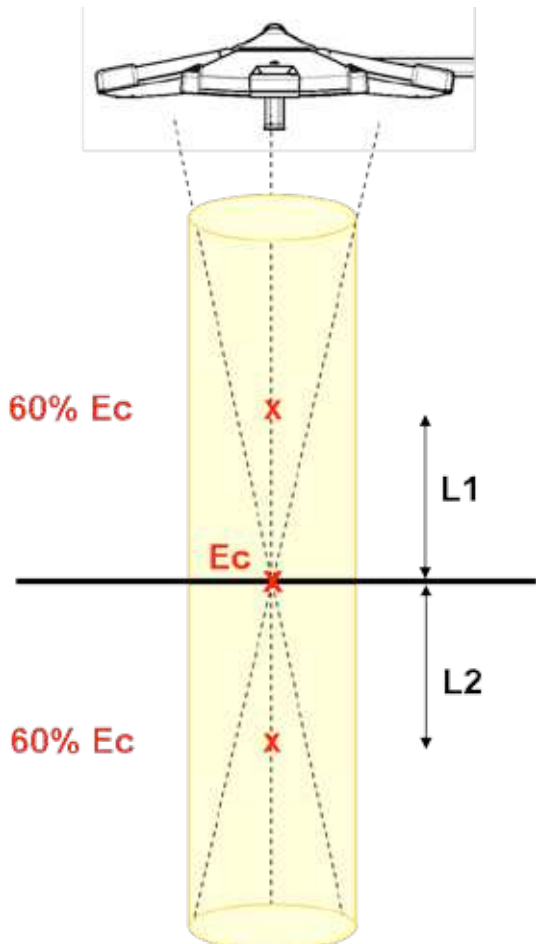

- The ST series lights are suitable for illumination of deep cavities.
- For the X3<sup>ST</sup>, at 60% Ec, L1+L2 = 66 cm

### Optical independence of each module

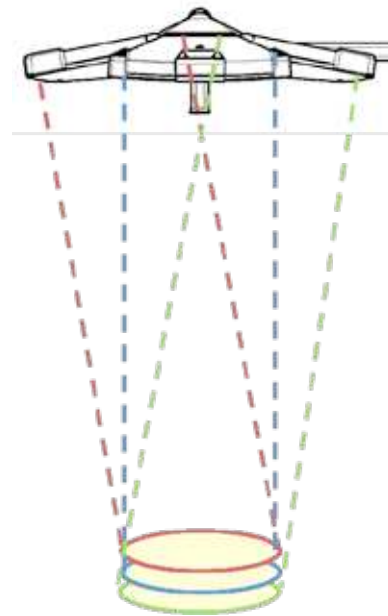

- Each LED module is optically independent from the others and is designed to illuminate a full spot at a distance of 1m.

- The optical independence of the LED modules improves **shadows dissolution** and **ensures excellent homogeneity of colours and light.**

## ENDO Mode

The standard functions of the X3<sup>ST</sup>, X2<sup>ST</sup> and X1<sup>ST</sup> lights include an ENDO mode. The ENDO mode allows the diffusion of ambient light suitable for performing procedures under imaging guidance and control: endoscopic and laparoscopic.



# MAINTENANCE AND LIFETIME

The X3<sup>ST</sup>, X2<sup>ST</sup> and X1<sup>ST</sup> lights are designed for long life. Their innovative design, the selection of latest-generation high-performance LEDs, and the electronic control system contribute to the reliability of the SURGIRIS lights.

## Focalization without mechanical movement



One of the advantages of the FOCUSMATIC™ technology is the ability to provide focalization with **no mechanical movement**. Unlike most surgical lights, the X3<sup>ST</sup>, X2<sup>ST</sup> and X1<sup>ST</sup> lighting cupolas, designed and manufactured by SURGIRIS, do not include moving parts subject to wear and tear. This means that maintenance is greatly reduced.

## Preventive maintenance of the LEDs by electronic management



The APM is an automatic preventive maintenance system integrated in the lighting cupola. The LEDs are controlled and protected continuously by a microprocessor that provides management and control.



The CCL function also includes **electronic management of LED aging**.

## Meticulous design

The X3<sup>ST</sup>, X2<sup>ST</sup> and X1<sup>ST</sup> surgical lights are designed and manufactured in France by SURGIRIS.

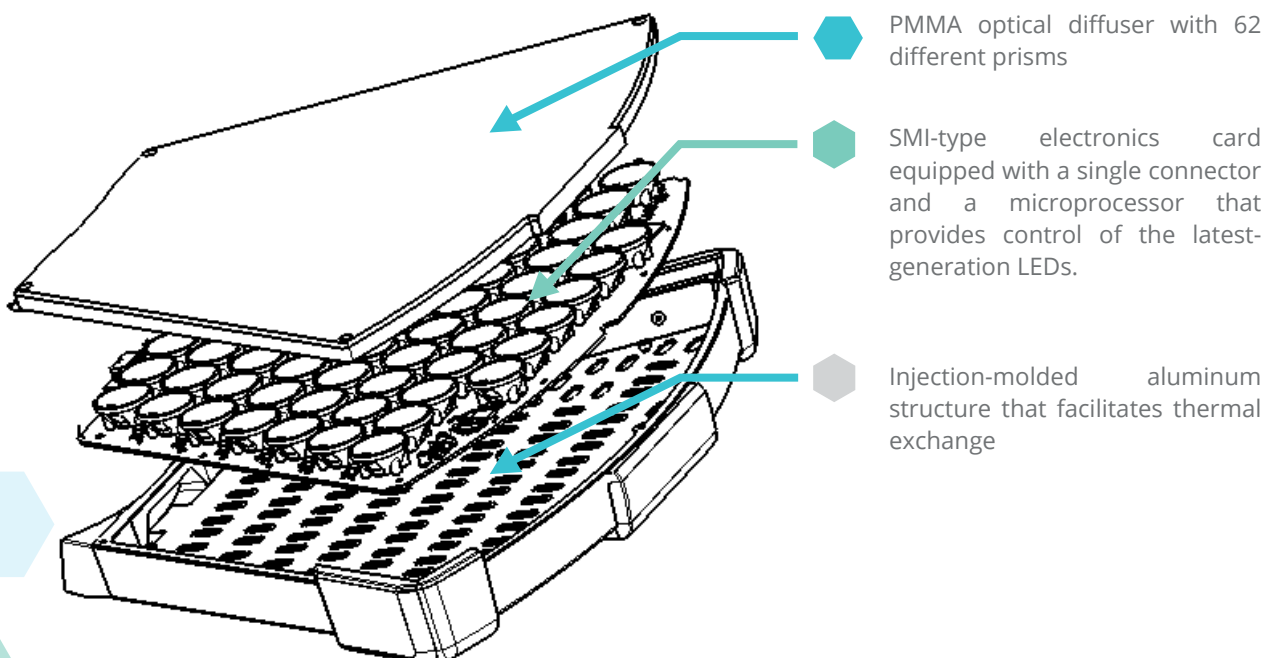



# VIDEO SOLUTIONS

## HD Plug'n Play Camera

A video camera can be plugged in the centre of the cupola or to the suspension system to capture images for teaching or documentation archiving.

- ◆ HD image quality
- ◆ Wireless controls



## Image transfer

Packs E-Comot



### Solutions for:

Streaming, Video over IP, Videoconference,  
Supervision, Recording and Archiving

## Integrated operating theatres

The lighting and the video camera can also be controlled through most of the integration solutions for operating theatres. SURGIRIS collaborates with partners specialized in OR integration in order to offer you a solution adapted to your needs.

SURGIRIS offers a range of HD monitors complementing the support arms for image display.

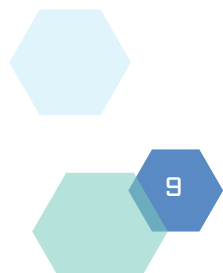

# MAIN OPTIONS



## Remote control

Wall-mounted panel to control the lighting system through wireless communication technology.



## Support for single-use handle



## Backup supply

"EMERGILED" combines a power supply and a backup power supply in a single box. In case of mains power failure, switchover to the backup is done instantly\* with no loss of lighting level.

\* floating switchover without relays

# TECHNICAL GUIDE

## Available configurations

### ◆ Ceiling-mounted

Ceiling-mounted suspensions allow unlimited rotation and integration of arms for a camera or monitors, in addition to the lighting cupolas.

#### Single light



#### Double light

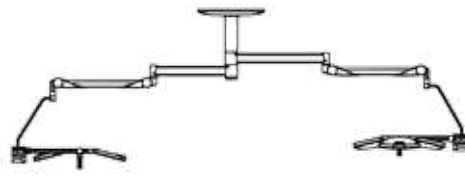

#### Double light with monitor and camera arm

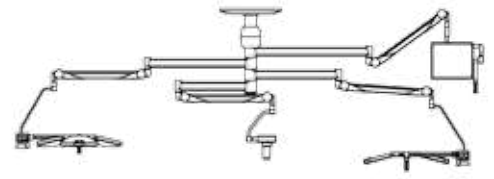

#### Triple light



### ◆ Mobiles

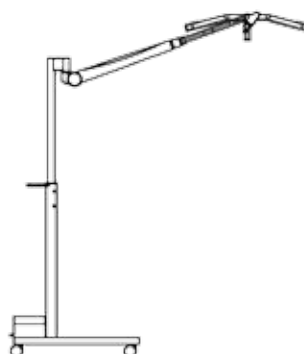

These configurations are presented as examples. Other configurations are also possible. Please consult us for a personalized proposal.

# TECHNICAL DATA

	X1 <sup>ST</sup>	X2 <sup>ST</sup>	X3 <sup>ST</sup>
<b>Light source</b>	LED	LED	LED
<b>Maximum central lighting (Ec)*</b>	100 000 Lux	160 000 Lux	160 000 Lux
<b>Adjustable illumination intensity*</b>	50 000 to 100 000 Lux	50 000 to 160 000 Lux	50 000 to 160 000 Lux
<b>Endoscopy mode : "ENDO"</b>	Yes	Yes	Yes
<b>D10*</b>	27 cm**	31 cm	33 cm
<b>D50*</b>	14 cm**	16 cm	17 cm
<b>Depth of field L1+L2 (60% Ec) 2008</b>	106 cm**	68 cm	66 cm
<b>Depth of field L1+L2 (20% Ec) 2003</b>	216 cm	118 cm	125 cm
<b>Focalization</b>	<b>Technology</b>  <ul style="list-style-type: none"> <li>• Electronically adjustable diameter of the illuminated field, with constant central illumination</li> <li>• With no mechanical movement</li> </ul>		
<b>Colour temperature*</b>	4000K	4000K	4000K
<b>LED life time</b>	60 000 h	60 000 h	60 000 h
<b>HD video preparation</b>	/	Optional	Optional
<b>Colour Rendering Index Ra*</b>	97	91	91

\* Typical values recorded under control by a notified body, at a distance of 1m, in accordance with norm IEC 60601-2-41 version 2008 (tolerance 0% to -7%).

These values are subject to modification in view of the technical evolution of the products and the updates.

\*\* (Typical values recorded focus mini)

The X3<sup>ST</sup>, X2<sup>ST</sup> and X1<sup>ST</sup> surgical lights are designed and manufactured in France by SURGIRIS and comply with the standards IEC 60601-1: 2012, IEC 60601-1-2: 2007/F1: 2010 and IEC 60601-2-41 Edition 2.0 2009/A1: 2013.



## Select a meticulous design

SURGIRIS is a French designer and manufacturer offering a wide range of LED surgical lights, ceiling pendants and distribution columns for OT, ICU & CCU. For more information, visit [www.surgiris.com](http://www.surgiris.com)

**Surgiris**  
*Design that cares*

**Registered Office, Factory and R&D  
SURGIRIS**

80 rue de la Gare • 59170 Croix • FRANCE

Tél: +33 (0)3.20.16.07.93 • Fax: +33 (0)3.20.95.40.19 • Mail: [contact@surgiris.com](mailto:contact@surgiris.com)



MADE IN FRANCE